

IR-Lumineszenzdiode (850 nm) mit hoher Ausgangsleistung
High Power Infrared Emitter (850 nm)
Lead (Pb) Free Product - RoHS Compliant

SFH 4058

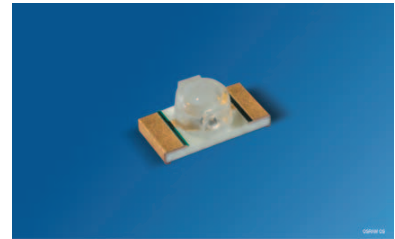

Wesentliche Merkmale

- Sehr kleines Gehäuse:
(LxBxH) 3.2 mm x 1.6mm x 1.1 mm
- Sehr hohe Gesamtleistung

Anwendungen

- Miniaturlichtschranken
- Industrieelektronik
- „Messen/Steuern/Regeln“
- Sensorik

Sicherheitshinweise

Je nach Betriebsart emittieren diese Bauteile hochkonzentrierte, nicht sichtbare Infrarot-Strahlung, die gefährlich für das menschliche Auge sein kann. Produkte, die diese Bauteile enthalten, müssen gemäß den Sicherheitsrichtlinien der IEC-Normen 60825-1 und 62471 behandelt werden.

Features

- Very small package:
(LxWxH) 3.2 mm x 1.6 mm x 1.1 mm
- High optical total power

Applications

- Miniature photointerrupters
- Industrial electronics
- For drive and control circuits
- Sensor technology

Safety Advices

Depending on the mode of operation, these devices emit highly concentrated non visible infrared light which can be hazardous to the human eye. Products which incorporate these devices have to follow the safety precautions given in IEC 60825-1 and IEC 62471.

Typ Type	Bestellnummer Ordering Code	Strahlstärkegruppierung¹⁾ ($I_F = 70 \text{ mA}$, $t_p = 20 \text{ ms}$) Radiant Intensity Grouping¹⁾ $I_e \text{ (mW/sr)}$
SFH 4058	Q65110A9218	$\geq 6.3 \text{ (typ. 15)}$

¹⁾ gemessen bei einem Raumwinkel $\Omega = 0.01 \text{ sr}$ / measured at a solid angle of $\Omega = 0.01 \text{ sr}$

Grenzwerte ($T_A = 25\text{ °C}$)**Maximum Ratings**

Bezeichnung Parameter	Symbol Symbol	Wert Value	Einheit Unit
Betriebs- und Lagertemperatur Operating and storage temperature range	T_{op}, T_{stg}	- 40 ... + 85	°C
Sperrspannung Reverse voltage	V_R	5	V
Vorwärtsgleichstrom Forward current	I_F	70	mA
Stoßstrom, $t_p = 10\ \mu\text{s}$, $D = 0$ Surge current	I_{FSM}	700	mA
Verlustleistung Power dissipation	P_{tot}	140	mW
Wärmewiderstand Sperrschicht - Umgebung bei Montage auf FR4 Platine, Padgröße je $5\ \text{mm}^2$ Thermal resistance junction - ambient mounted on PC-board (FR4), pads size $5\ \text{mm}^2$ each	R_{thJA}	540	K/W
Wärmewiderstand Sperrschicht - Lötstelle bei Montage auf Metall-Block Thermal resistance junction - soldering point, mounted on metal block	R_{thJS}	360	K/W

Kennwerte ($T_A = 25\text{ °C}$)**Characteristics**

Bezeichnung Parameter	Symbol Symbol	Wert Value	Einheit Unit
Wellenlänge der Strahlung Wavelength at peak emission $I_F = 70\ \text{mA}$, $t_p = 10\ \text{ms}$	λ_{peak}	860	nm
Schwerpunkts-Wellenlänge der Strahlung Centroid Wavelength $I_F = 70\ \text{mA}$, $t_p = 10\ \text{ms}$	$\lambda_{centroid}$	850	nm
Spektrale Bandbreite bei 50% von I_{max} Spectral bandwidth at 50% of I_{max} $I_F = 70\ \text{mA}$, $t_p = 10\ \text{ms}$	$\Delta\lambda$	42	nm
Abstrahlwinkel Half angle	φ	± 40	Grad deg.
Aktive Chipfläche Active chip area	A	0.04	mm^2

Kennwerte ($T_A = 25\text{ °C}$)

Characteristics (cont'd)

Bezeichnung Parameter	Symbol Symbol	Wert Value	Einheit Unit
Abmessungen der aktiven Chipfläche Dimension of the active chip area	$L \times B$ $L \times W$	0.2×0.2	mm ²
Schaltzeiten, I_e von 10% auf 90% und von 90% auf 10%, bei $I_F = 70\text{ mA}$, $R_L = 50\ \Omega$ Switching times, I_e from 10% to 90% and from 90% to 10%, $I_F = 70\text{ mA}$, $R_L = 50\ \Omega$	t_r , t_f	10	ns
Durchlassspannung Forward voltage $I_F = 70\text{ mA}$, $t_p = 20\text{ ms}$	V_F	1.6 (< 2.0)	V
Sperrstrom Reverse current	I_R	not designed for reverse operation	μA
Gesamtstrahlungsfluss Total radiant flux $I_F = 70\text{ mA}$, $t_p = 20\text{ ms}$	$\Phi_{e\text{ typ}}$	33	mW
Temperaturkoeffizient von I_e bzw. Φ_e , $I_F = 70\text{ mA}$ Temperature coefficient of I_e or Φ_e , $I_F = 70\text{ mA}$	TC_I	- 0.5	%/K
Temperaturkoeffizient von V_F , $I_F = 70\text{ mA}$ Temperature coefficient of V_F , $I_F = 70\text{ mA}$	TC_V	- 0.7	mV/K
Temperaturkoeffizient von λ , $I_F = 70\text{ mA}$ Temperature coefficient of λ , $I_F = 70\text{ mA}$	TC_λ	+ 0.3	nm/K

Strahlstärke I_e in Achsrichtung¹⁾gemessen bei einem Raumwinkel $\Omega = 0.01$ sr**Radiant Intensity I_e in Axial Direction**at a solid angle of $\Omega = 0.01$ sr

Bezeichnung Parameter	Symbol	Werte Values			Einheit Unit
		SFH 4058			
		-Q	-R	-S	
Strahlstärke Radiant intensity $I_F = 70$ mA, $t_p = 20$ ms	$I_{e \text{ min}}$ $I_{e \text{ max}}$	6.3 12.5	10 20	16 32	mW/sr mW/sr
Strahlstärke Radiant intensity $I_F = 500$ mA, $t_p = 25$ μ s	$I_{e \text{ typ}}$	36	55	90	mW/sr

¹⁾ Nur eine Gruppe in einer Verpackungseinheit (Streuung kleiner 2:1) /
Only one bin in one packing unit (variation lower 2:1)

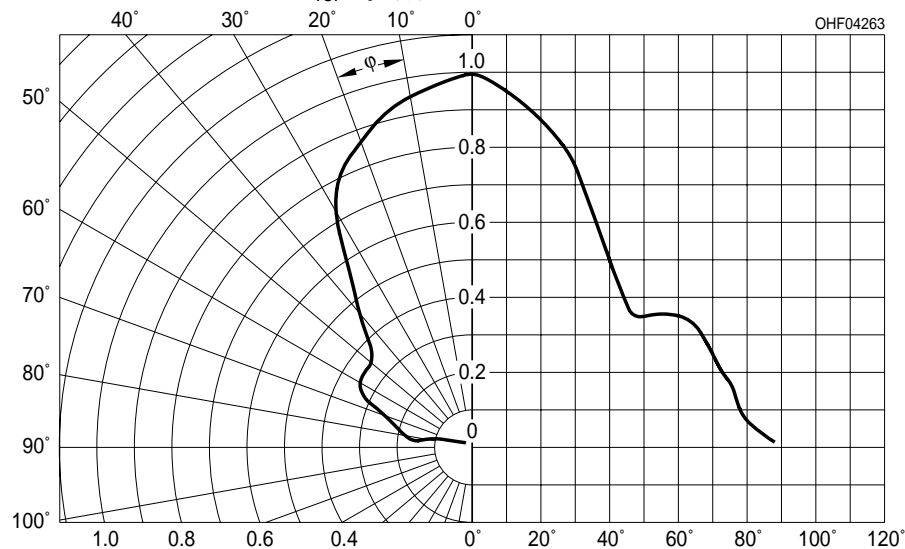
Abstrahlcharakteristik**Radiation Characteristics $I_{\text{rel}} = f(\varphi)$** 

Relative Spectral Emission

$I_{rel} = f(\lambda)$

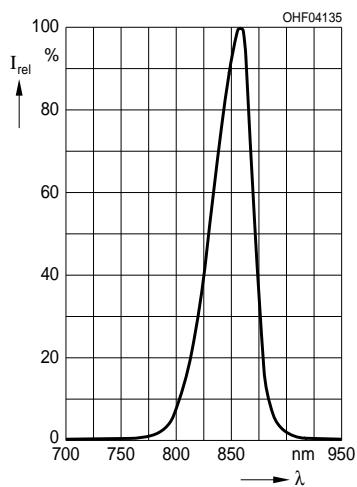

Radiant Intensity $\frac{I_e}{I_e(70 \text{ mA})} = f(I_F)$

Single pulse, $t_p = 25 \mu\text{s}$

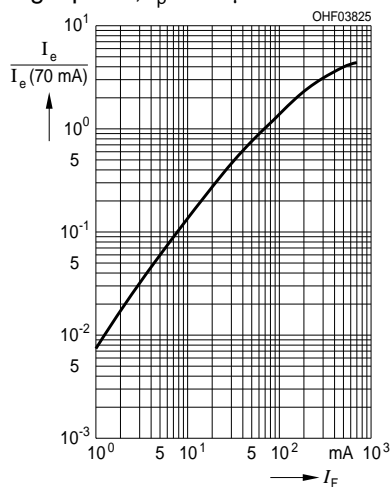

Max. Permissible Forward Current

$I_F = f(T_A), R_{thJA} = 540 \text{ K/W}$

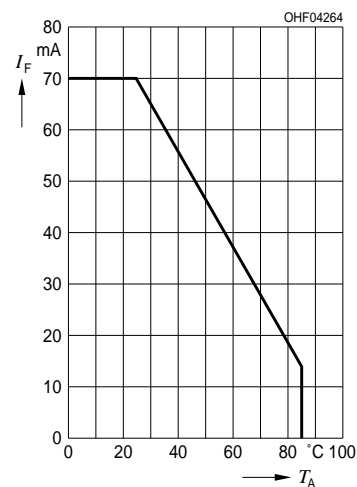

Forward Current $I_F = f(V_F)$

Single pulse, $t_p = 100 \mu\text{s}$

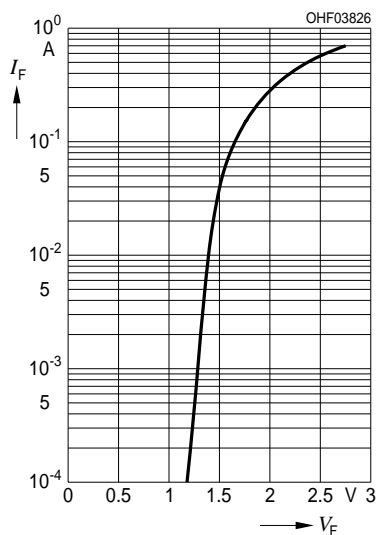

Permissible Pulse Handling Capability

$I_F = f(\tau), T_A = 25 \text{ }^\circ\text{C}$,
duty cycle $D =$ parameter

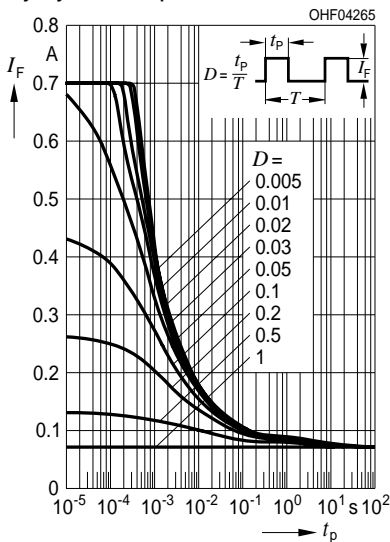

Permissible Pulse Handling Capability

$I_F = f(\tau), T_A = 85 \text{ }^\circ\text{C}$,
duty cycle $D =$ parameter

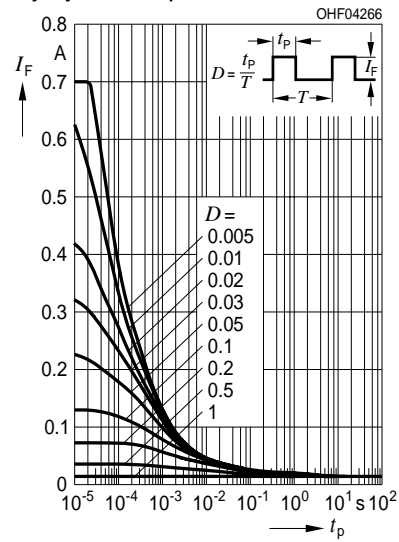

Maßzeichnung Package Outlines

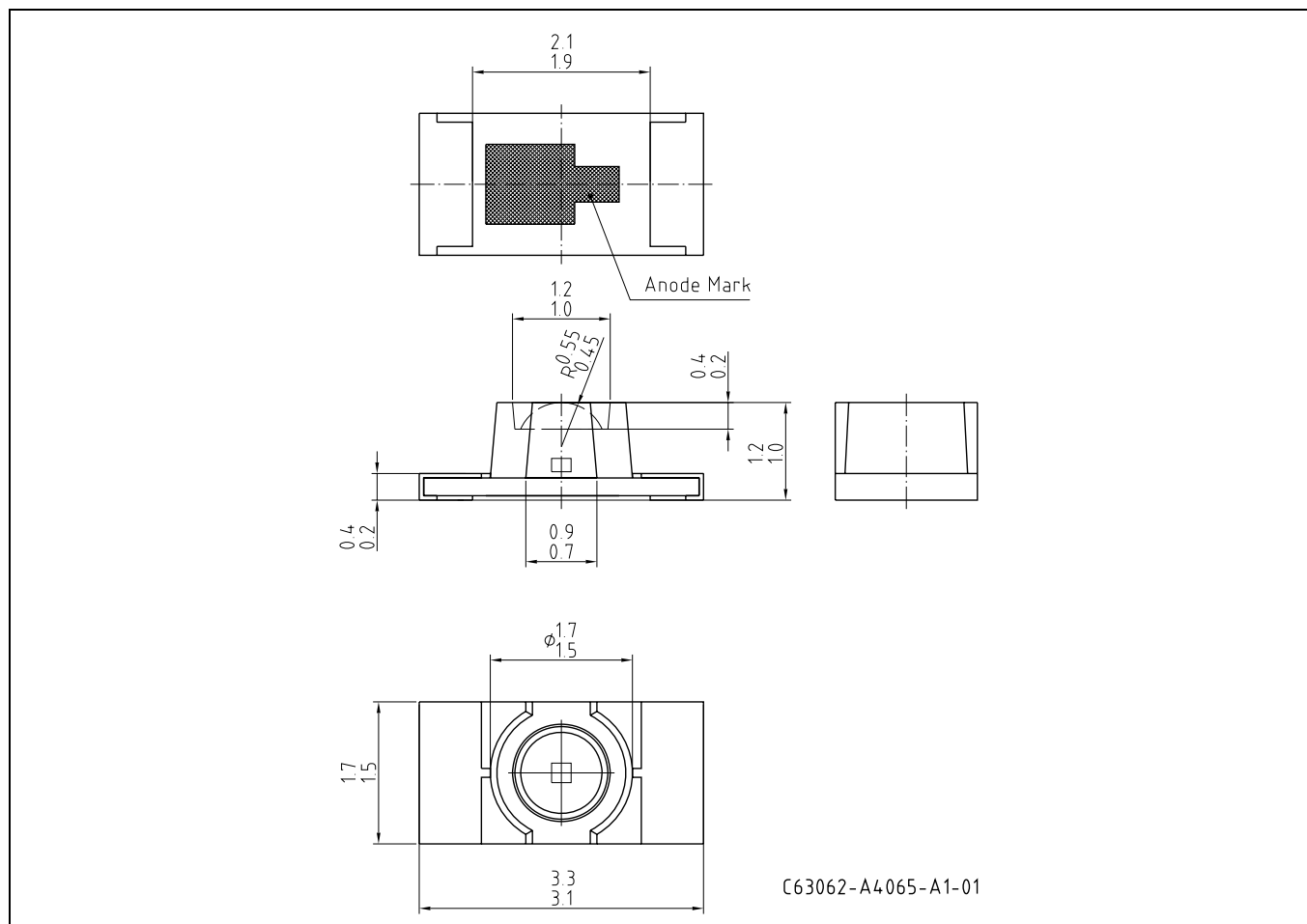

Maße in mm/ Dimensions in mm.

Gehäuse / Package	Chip LED/ Chip LED
Farbe / Colour	Farblos klar / colourless clear
Gehäusemarkierung/ Package marking	Anode / anode

Gurtung / Polarität und Lage

Verpackungseinheit 2000/Rolle, ø180 mm

Method of Taping / Polarity and Orientation

Packing unit 2000/reel, ø180 mm

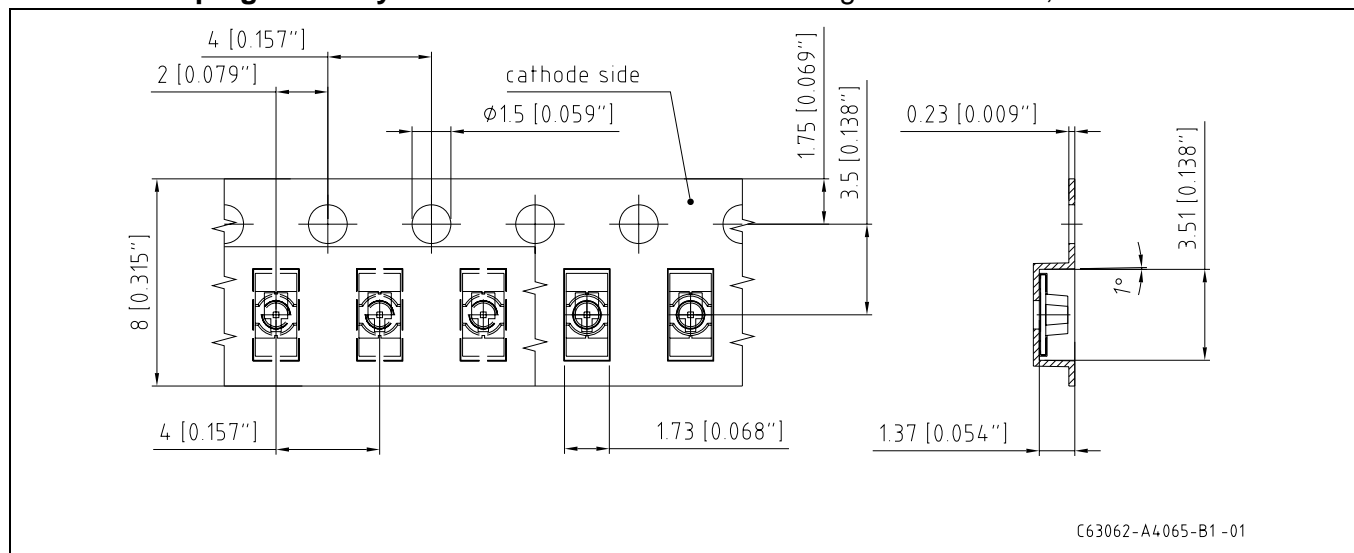

Maße in mm (inch) / Dimensions in mm (inch).

**Empfohlenes Lötpaddesign
Recommended Solder Pad**

Reflow Löten
Reflow Soldering

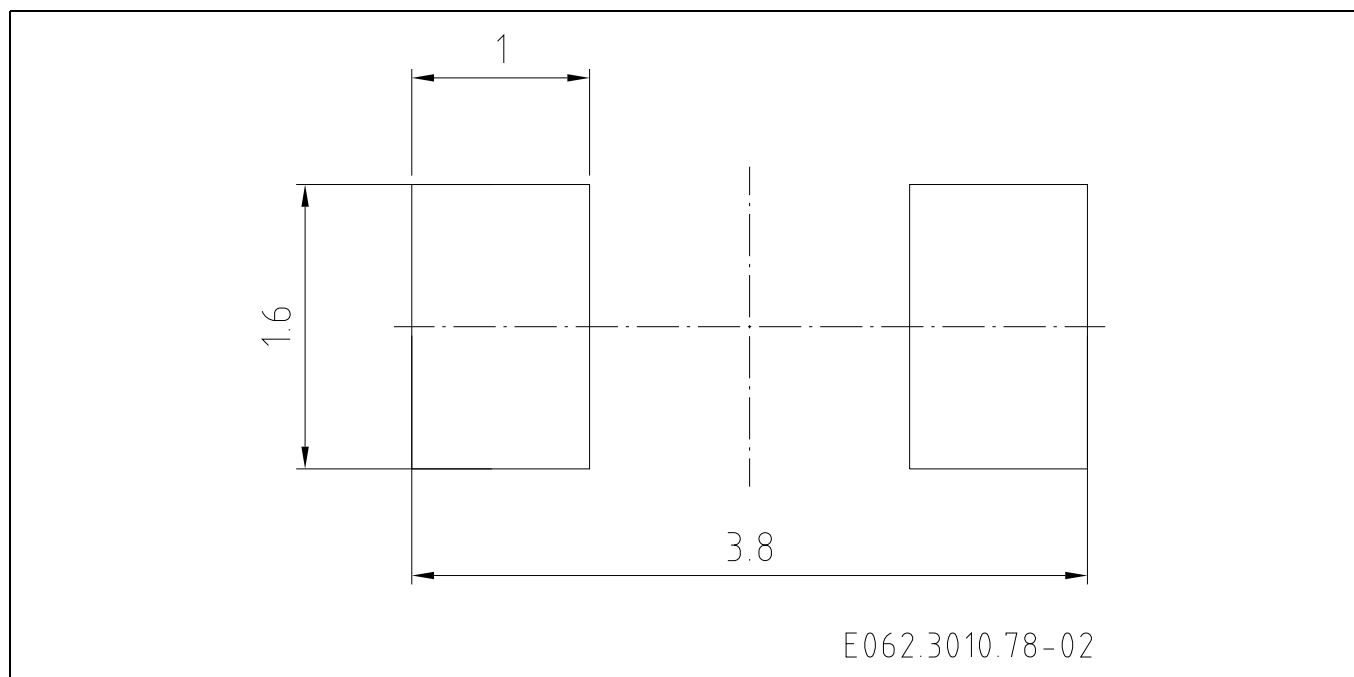

Maße in mm / Dimensions in mm.

Lötbedingungen
Soldering Conditions
Reflow Lötprofil für bleifreies Löten
Reflow Soldering Profile for lead free soldering

Vorbehandlung nach JEDEC Level 3
 Preconditioning acc. to JEDEC Level 3
 (nach J-STD-020C)
 (acc. to J-STD-020C)

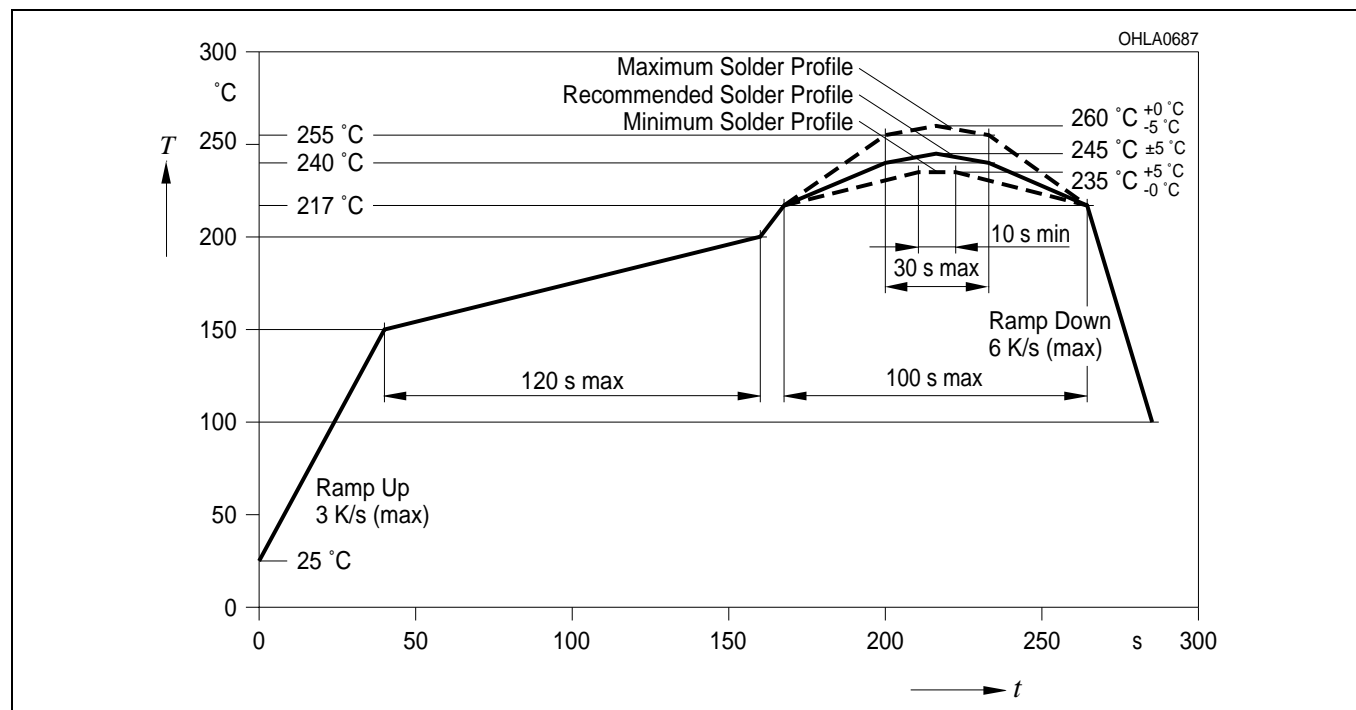

Published by
OSRAM Opto Semiconductors GmbH
 Leibnizstrasse 4, D-93055 Regensburg
www.osram-os.com

© All Rights Reserved.

The information describes the type of component and shall not be considered as assured characteristics. Terms of delivery and rights to change design reserved. Due to technical requirements components may contain dangerous substances. For information on the types in question please contact our Sales Organization.

Packing

Please use the recycling operators known to you. We can also help you – get in touch with your nearest sales office. By agreement we will take packing material back, if it is sorted. You must bear the costs of transport. For packing material that is returned to us unsorted or which we are not obliged to accept, we shall have to invoice you for any costs incurred.

Components used in life-support devices or systems must be expressly authorized for such purpose! Critical components¹, may only be used in life-support devices or systems² with the express written approval of OSRAM OS.

¹ A critical component is a component used in a life-support device or system whose failure can reasonably be expected to cause the failure of that life-support device or system, or to affect its safety or effectiveness of that device or system.

² Life support devices or systems are intended (a) to be implanted in the human body, or (b) to support and/or maintain and sustain human life. If they fail, it is reasonable to assume that the health of the user may be endangered.

EU RoHS and China RoHS compliant product



此产品符合欧盟 RoHS 指令的要求；

按照中国的相关法规和标准，不含有毒有害物质或元素。

Mouser Electronics

Related Product Links

[720-SFH4058 - Osram Opto Semiconductor SFH 4058](#)